









INSTALLATION INSTRUCTION FOR SWDD



 Integrated linear LED luminaire made of aluminum, based on optical diffuser arranged in three rows directly at LED modules. Wide choice of optics with different beam angles allows customization of light distribution. To use with SWE trunking system. For storage areas etc.

TECHNICAL DATA

W	Power	45 - 160 W
V	Tension	220-240 V - 50/60 Hz
	Power supply	OSRAM Industrial Driver
	Management	ON-OFF / DALI / DIMM
	Housing	aluminum
	Housing color	silver / black / white
	Mounting	single / linear / trunking
	IP Class	IP20 / IP 44 (with cover)
	Ambient temperature	(ta) -25° ... +35°

DIMENSIONS

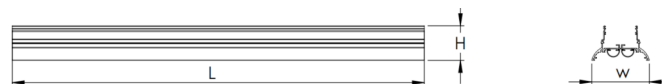
INDEX	L	W	H	KG (NET)
SWDD[M][C]09[X]	860 mm	80 mm	47 mm	1.35 KG
SWDD[M][C]12[X]	1145 mm	80 mm	47 mm	1.85 KG
SWDD[M][C]14[X]	1440 mm	80 mm	47 mm	2.55 KG
SWDD[M][C]17[X]	1720 mm	80 mm	47 mm	2.80 KG
SWDD[M][C]20[X]	2002 mm	80 mm	47 mm	3.40 KG
SWDD[M][C]23[X]	2290 mm	80 mm	47 mm	3.55 KG
SWDD[M][C]28[X]	2860 mm	80 mm	47 mm	4.60 KG
SWDD[M][C]34[X]	3435 mm	80 mm	47 mm	5.70 KG
SWDD[M][C]40[X]	4008 mm	80 mm	47 mm	6.80 KG

SINGLE - INSTALLATION OF SWD LUMINAIRE ON SUSPENSION
WARNING !
 DANGER OF DEATH THROUGH ELECTRIC SHOCK

Make sure no voltage is applied while performing installation
Always connect cables and wires according to wire labeling and colors
Maximum current should not exceed 16A in one power feed circuit

1. Carefully take out the SWD luminaires from the box and place them on a stable surface.



2. Prepare mounting slings (suspension) for the installation (min. 2 slings per fixture)

3. Side covers and top blinding cover should be already installed on the luminaires.

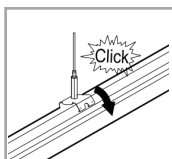

4. Place the mounting slings on top of SWDD luminaire profile guidelines and push it until you hear a click.

5. Place the mounting slings on top of SWDD luminaire profile guidelines and push it until you hear a click.

6. Hang the fixture at designated places by means of a rod, cord, or steel wire (if supplied).

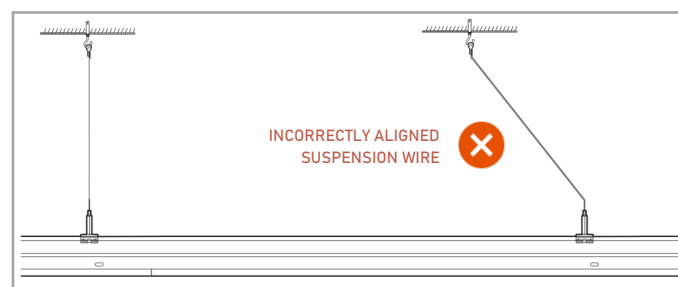
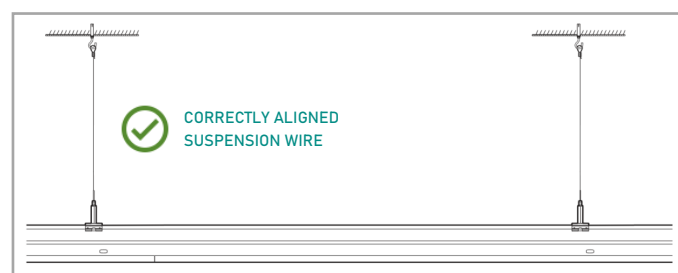

ATTENTION !
 DANGER OF DEATH THROUGH ELECTRIC SHOCK

Prior to the installation you must turn off main power. Leave main power switch off until the installation ends!

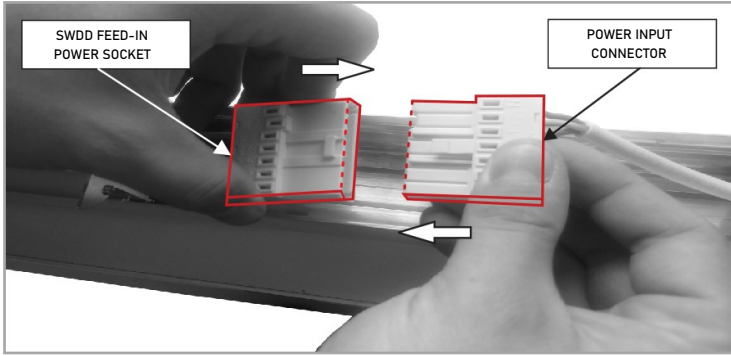
7. Connect luminaire to the electrical installation (feed). Use the already installed socket from the SWDD luminaire. Connection schematics you find at the end of this manual.

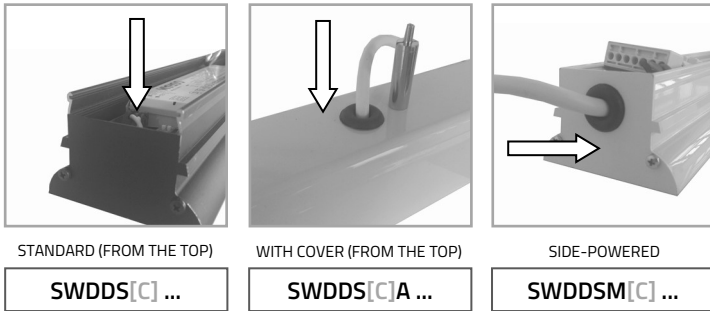

Power to luminaire can be supplied in various different ways according to the SWDD version (mounting type and cover):



8. Double-check the wiring. Make sure that all connectors are connected to each other according to labeling.

! IMPORTANT INSTALLATION ADVICE

Installation of lighting fixtures to a live electrical installation must be carried out by qualified personnel.

Fully operational electrical installation is necessary for the installation of lighting fixtures.

Before installation turn off main power circuit.

Disassembling attempts or altering trunking and fixtures' internal components is not allowed in any case!

9. The luminaires are now powered and ready to use.

LINEAR - INSTALLATION OF SWD LUMINAIRE TO OTHER LUMINAIRES

WARNING !

⚠ DANGER OF DEATH THROUGH ELECTRIC SHOCK

Make sure no voltage is applied while performing installation
Always connect cables and wires according to wire labeling and colors
Maximum current should not exceed 16A in one power feed circuit

1. Carefully take out the SWD luminaires from the box and place them on a stable surface.



2. Prepare mounting slings (suspension) for the installation (min. 2 slings per fixture)

LINEAR LED SYSTEM INSTALLATION MANUAL

3. Prepare side covers and top blinding cover nearby for further installation. The elements should be supplied together with the system.

4. Place the mounting slings on top of SWDD luminaire profile guidelines and push it until you hear a click.

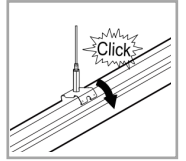

5. Align SWDD luminaires to each other. Place both luminaires so that end of unit A will be aligned to the front of unit B.

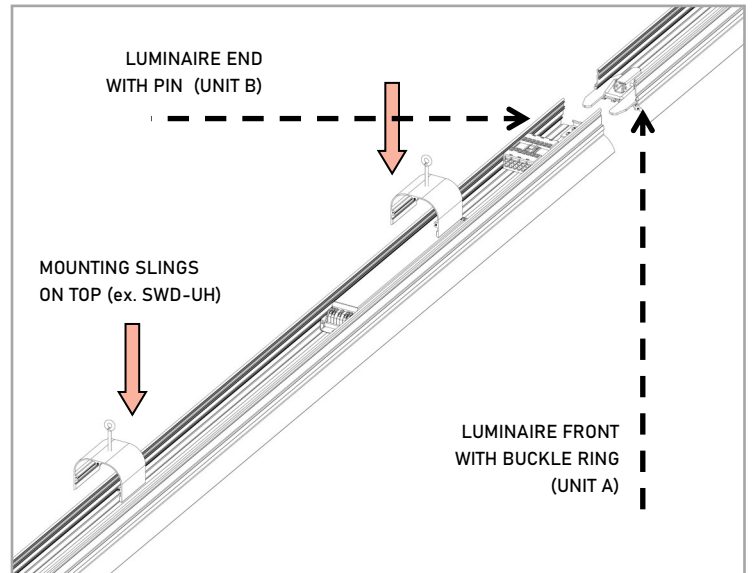

6. Hang the fixture at designated places by means of a rod, cord, or steel wire (if supplied).

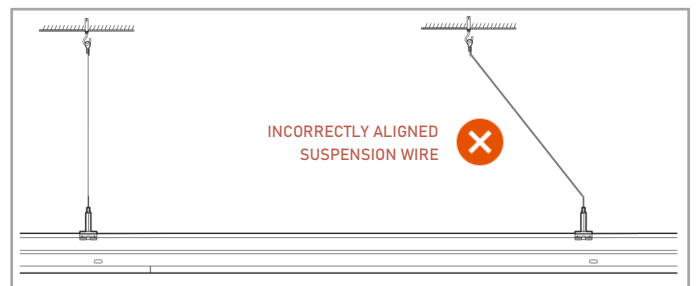
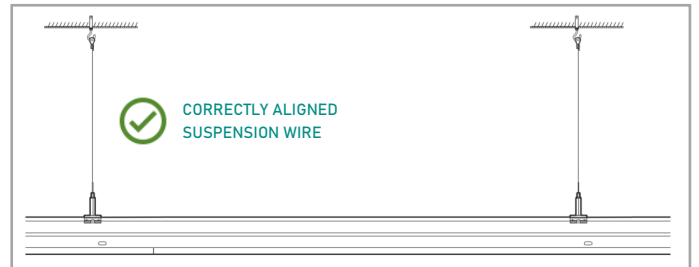

7. Join the rails together. Place a fork of luminaire **unit A** into **unit B**.

LINEAR LED SYSTEM INSTALLATION MANUAL

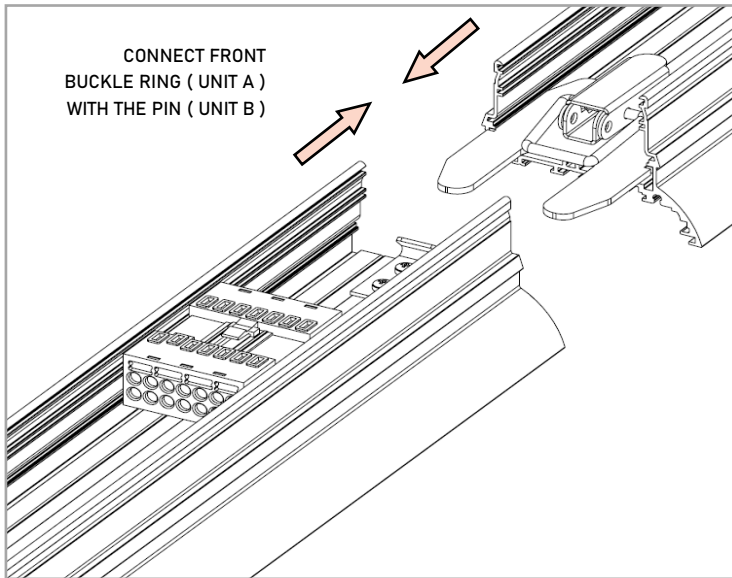

8. Place the buckle ring (from **unit A**) onto the pin (from **unit B**)
9. Tighten the buckle clamp by pressing it down until it clicks!

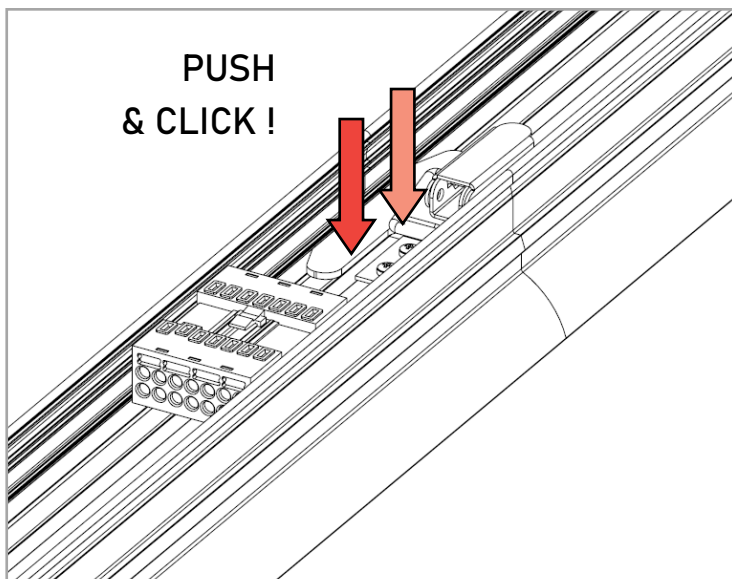

ATTENTION !

DANGER OF DEATH THROUGH ELECTRIC SHOCK

Prior to the installation you must turn off main power. Leave main power switch off until the installation ends!

10. Connect the power connector from **unit A** to a socket from **unit B**. The luminaires should be now wired one to each other by the connectors.

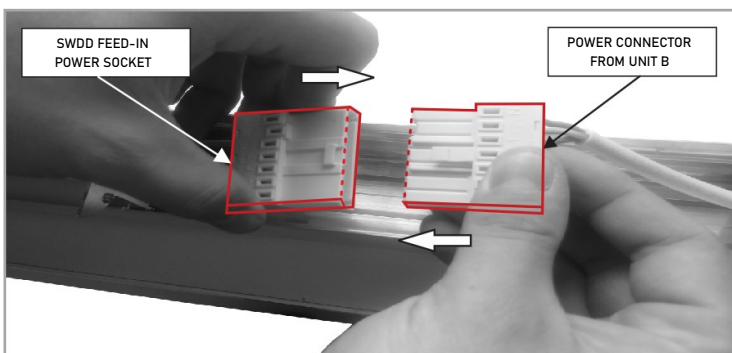

11. Connect luminaire line to the electrical installation (feed). Use the already installed socket from the SWDD luminaire. Connection schematics you find at the end of this manual.

Power to luminaire can be supplied in various different ways according to the SWDD version (mounting type and cover):

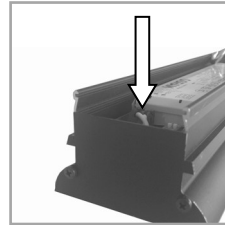

STANDARD (FROM THE TOP)

SWDDL[C] ...

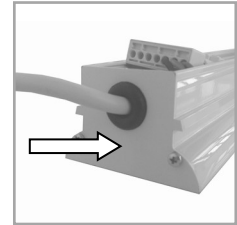

SIDE-POWERED

SWDDL[C] A ...

IMPORTANT INSTALLATION ADVICE

Installation of lighting fixtures to a live electrical installation must be carried out by qualified personnel.

Fully operational electrical installation is necessary for the installation of lighting fixtures.

Before installation turn off main power circuit.

Disassembling attempts or altering trunking and fixtures' internal components is not allowed in any case!

12. Double-check the wiring. Make sure that all connectors are connected to each other according to labeling.

13. After proper connecting the luminaires they can be closed by means of side caps (covers). Please ensure that all lines are closed from both sides.

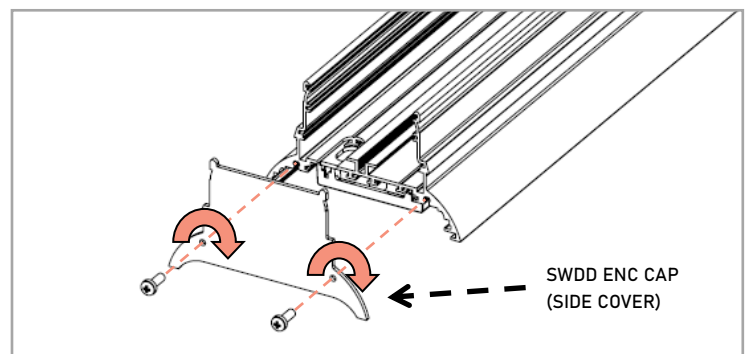

14. The luminaires are now powered and ready to use.

EUROLINE - INSTALLATION OF SWD LUMINAIRE ON SWE TRUNKING RAIL

1. Carefully take out the SWE trunking rails from the box and place them on a stable surface.



2. Prepare mounting slings (suspension) for the installation (min. 2 slings per fixture).

3. Prepare side covers and top blinding cover nearby for further installation. The elements should be supplied together with the system.

4. Align SWE trunking rails to each other. Place both rails so that end of **unit A** will be aligned to the front of **unit B**.

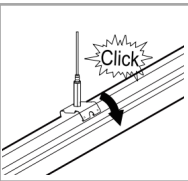
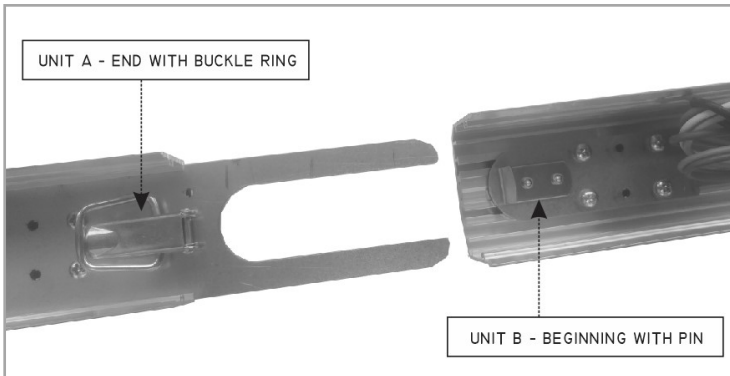

5. Place the mounting hooks or cord hangers on SWE profile guidelines.

6. Hang the fixture at designated places by means of a rod, cord, or chain.

7. Connect the power connector from **unit A** to a socket from **unit B**. The rails should be now wired one to each other by the connectors.

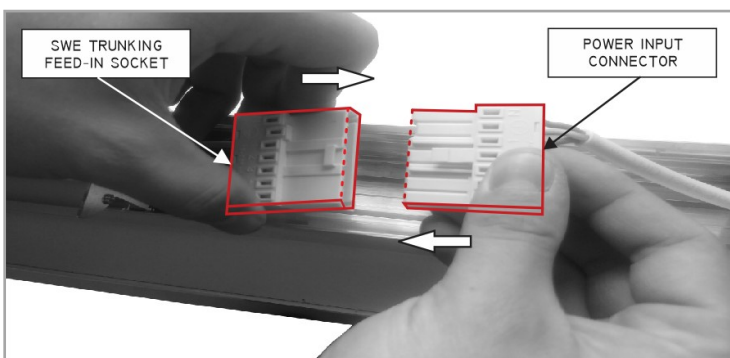

8. Join the rails together. Place a fork of **unit A** into **unit B**.

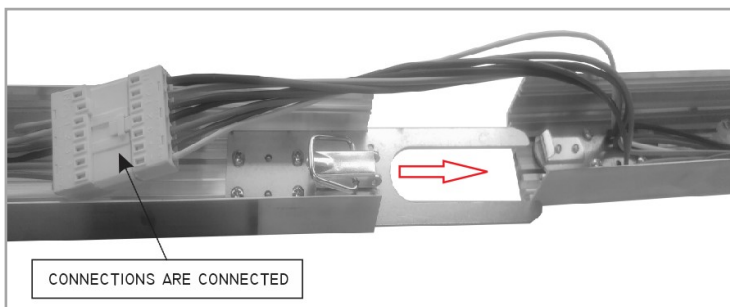

9. Place the buckle ring (from unit A) onto the pin (from unit B).

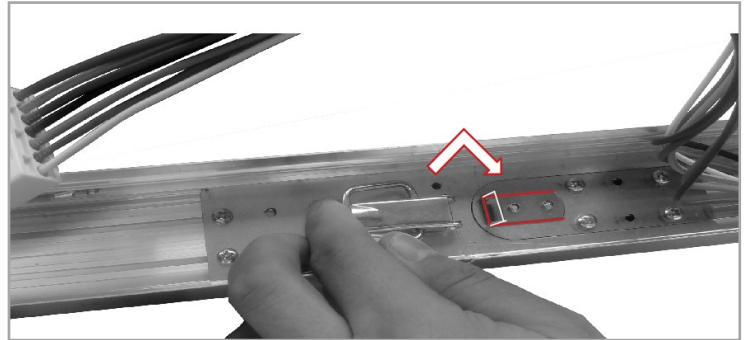

10. Tighten the clamp by pressing it down until it clicks.

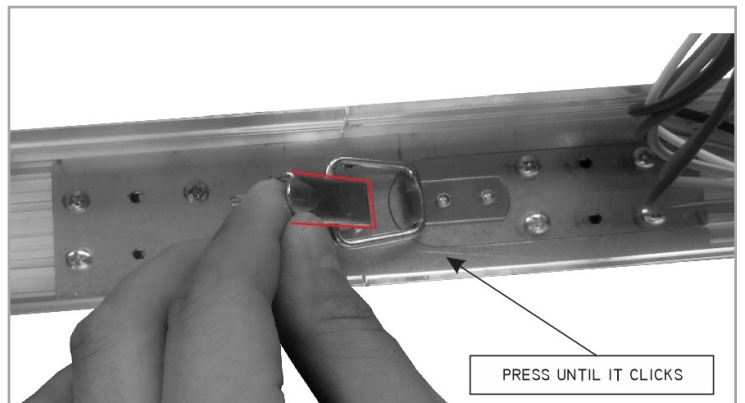

11. Set all hanging trunking rails horizontally - in perfect position.

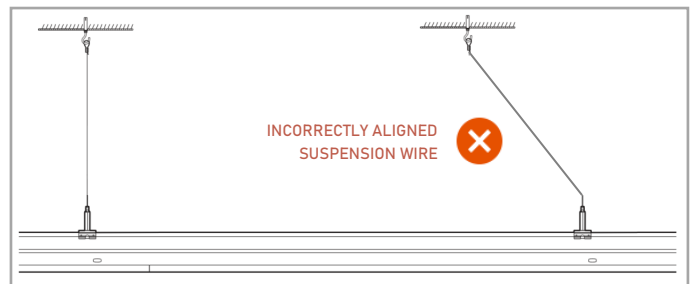
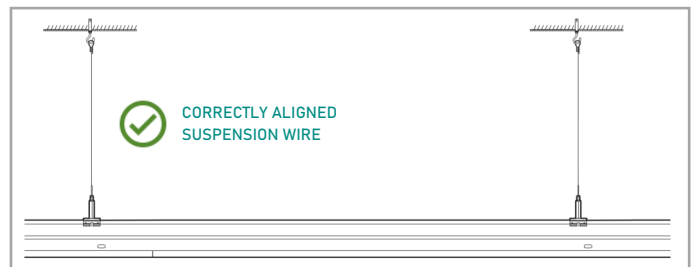

IMPORTANT INSTALLATION ADVICE

Installation of lighting fixtures to a live electrical installation must be carried out by qualified personnel.

Before installation turn off main power circuit.

Disassembling attempts or altering trunking and fixtures' internal components is not allowed in any case!



12. Connect trunking to the electrical installation (feed). Use the already-installed socket from the SWE trunking unit.

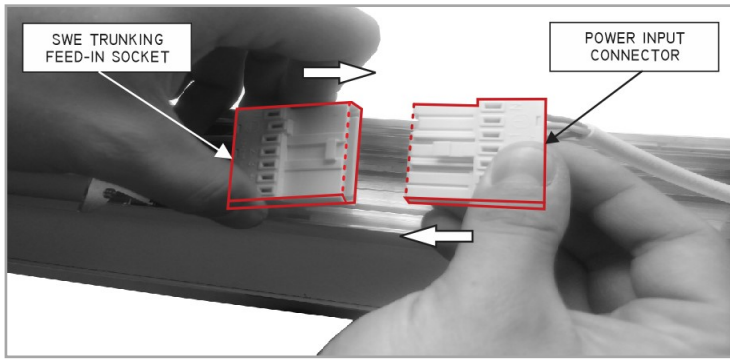

13. After proper connecting trunking can be closed by means of side caps (covers). Please ensure that all trunking lines are closed from both sides.

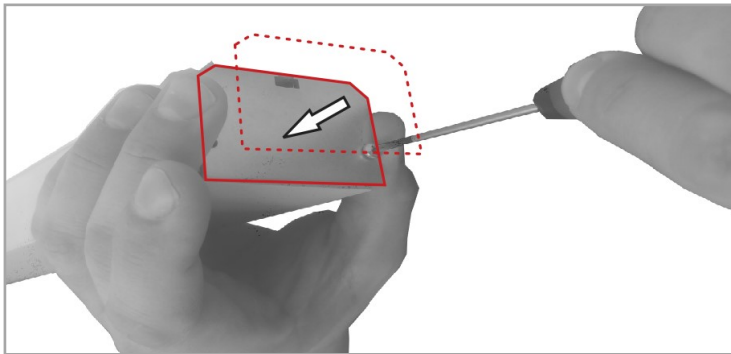

14. The SWE trunking is now ready for SWD luminaire installation.

15. Locate an internal WAGO socket and a safety hook inside SWE trunking unit. The connector will be used to connect and supply power to SWD luminaires.

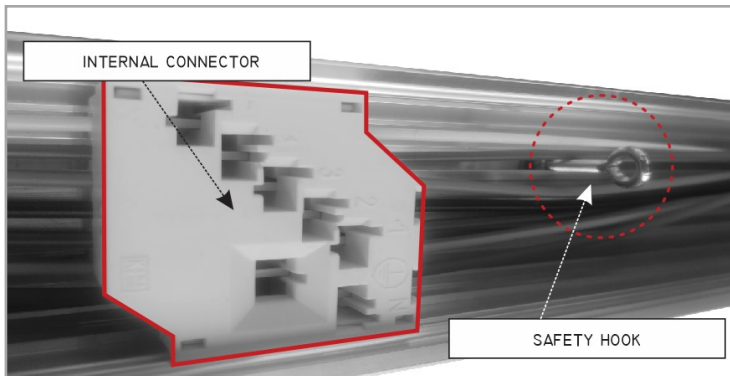

16. Fasten SWDD luminaire safety lead to the safety hook of the trunking unit.

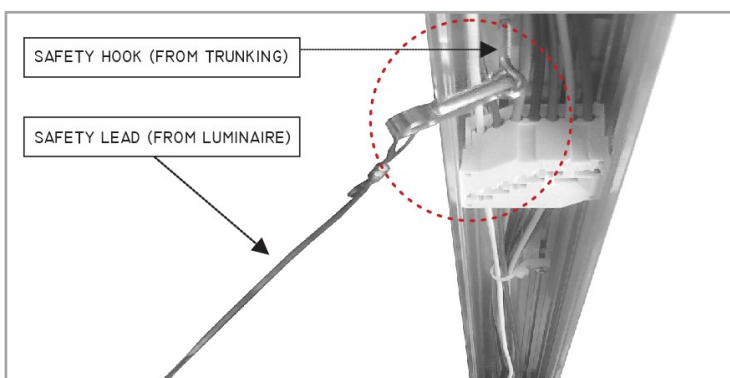

LINEAR LED SYSTEM INSTALLATION MANUAL

17. In SWDD luminaire, slide the knob connector knob to which brown cable is attached. From here you can select the electric phase (L1 / L2 / L3). For standard leave the knob on L1.

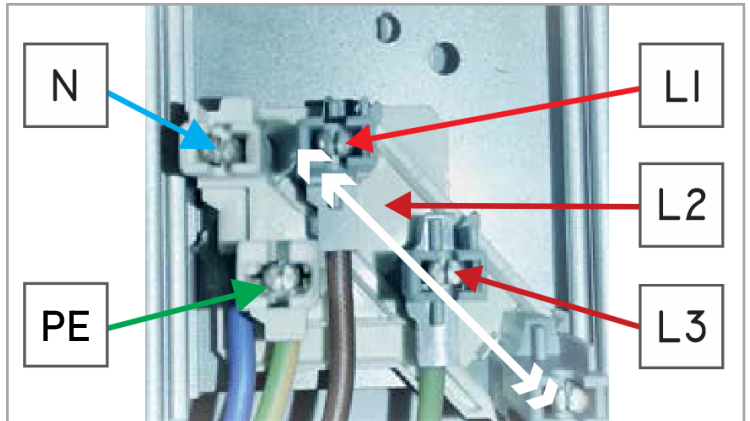

18. Secure the SWDD luminaires by means of SWD-O safety clips. Attach the clips on the side of SWD luminaire and SWE trunking so they will be binded together. Use at least two clips (4 clips recommended) for one luminaire. Clips must be installed on both sides of luminaires!

WARNING!

ALWAYS REMEMBER TO SECURE LUMINAIRES BY MEANS OF SAFETY HOOKS, SAFETY LEAD AND SAFETY CLIPS!

19. Place SWDD luminaire on the already installed SWE trunking rail. Make sure that male and female connectors are in right positions.

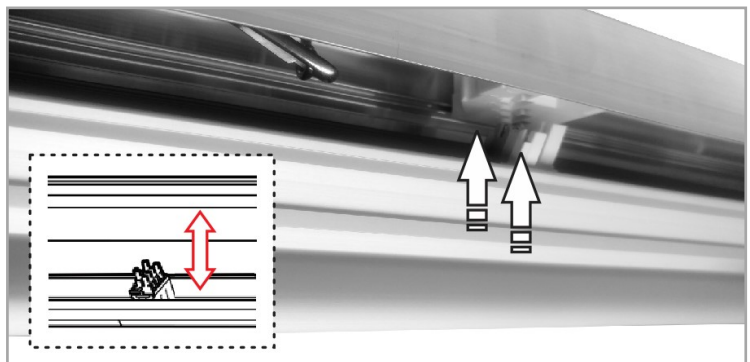

20. Join SWDD luminaire with SWE trunking rail by connecting the socket and the connector. Press them slightly together.

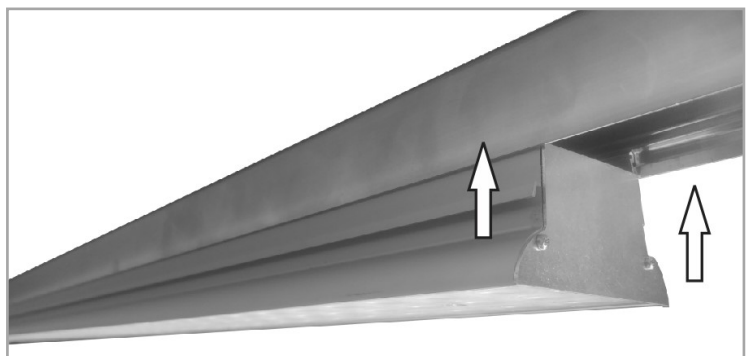

21. Mount the blinding cover stripe by pressing it gently. It should click to the rail easily.

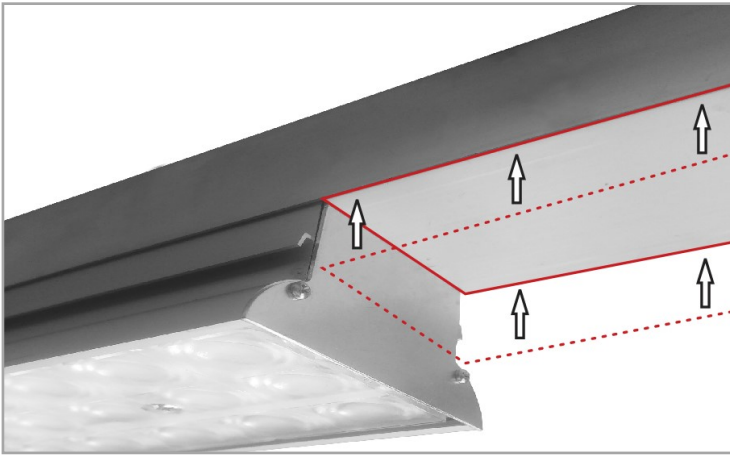

LINEAR LED SYSTEM INSTALLATION MANUAL

22. Luminaires should be now connected and powered by SWE trunking rail.

23. Secure the SWDD luminaires and SWE trunking line by means of SWD-O safety clips included in the package.

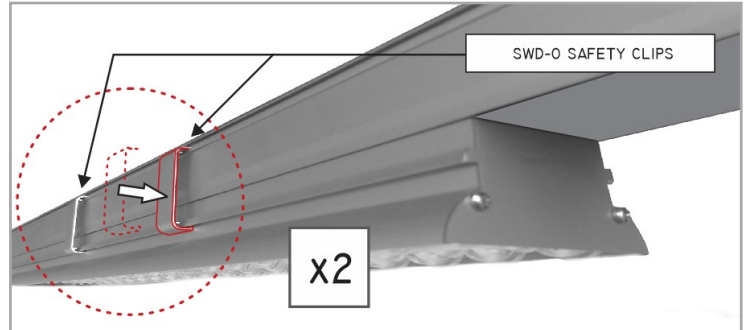

CONNECTION SCHEMATICS

SWDDE[C] ...

FOR EUROLINE VERSION

SWE TRUNKING UNIT CONNECTION:

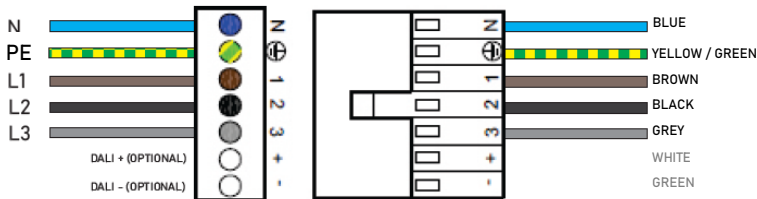

CONNECTION TO SWE



SWDDL7[C] ...

FOR LINEAR 3-PHASE VERSION + DALI

SWDD UNIT CONNECTION:

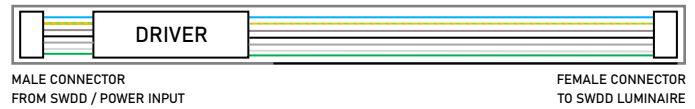
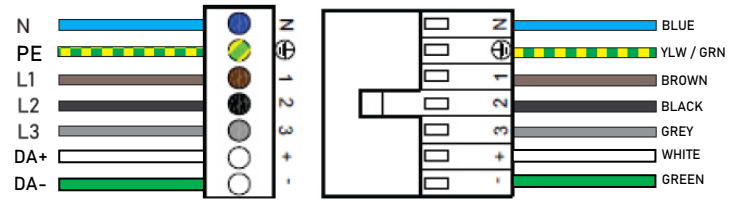

SWDDL3[C] ...

FOR LINEAR 1-PHASE VERSION

SWDD UNIT CONNECTION:

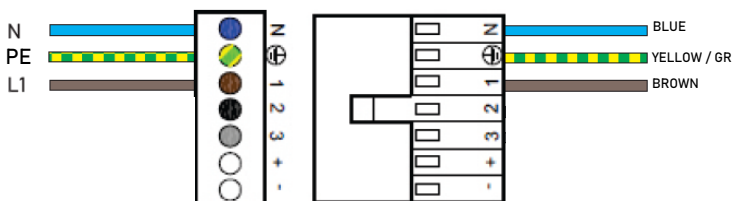

SWDDS[C] ...

FOR SINGLE INSTALLATION

SWDD UNIT CONNECTION:

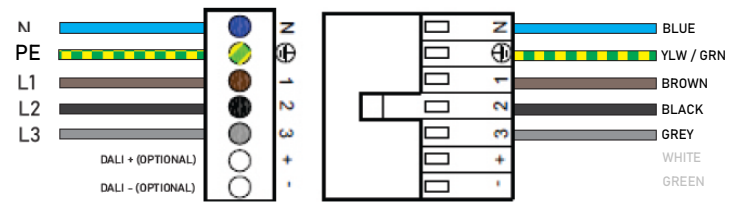

SWDDL[C] ...

FOR LINEAR 3-PHASE VERSION

SWDD UNIT CONNECTION:

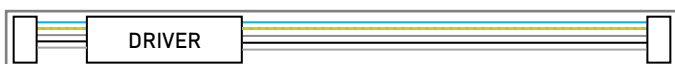
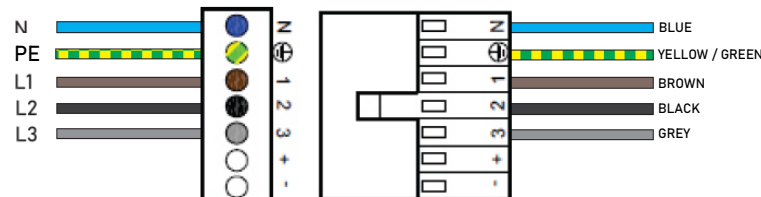

EUROLEDLIGHTING R. NOWAK I WSPÓLNICY Sp. J.

Przemysłowa 23/24 / 76-200 Słupsk / Poland
www.euroledlighting.com / info@euroledlighting.com